

**CROWN**



# **INSTRUCTION MANUAL**

**POWER LINE TWO  
STEREO AMPLIFIER**



# **INSTRUCTION MANUAL**

## **POWER LINE TWO STEREO AMPLIFIER**

**CROWN INTERNATIONAL, INC. 1718 W. MISHAWAKA RD. ELKHART, INDIANA 46517**

© 1984 Crown International, Inc.  
K80086-0  
12/84



The information furnished in this manual does not include all of the details of design, production, or variations of the equipment. It does not cover all the possible contingencies which may arise during operation, installation, or maintenance. Should special problems arise, or further information be desired, please contact the Crown International Customer Services Department.

Crown International  
1718 W. Mishawaka Rd.  
Elkhart, Indiana 46517  
Ph: (219) 294-8000

## **WARNING**

**TO PREVENT SHOCK OR FIRE HAZARD DO NOT EXPOSE TO  
RAIN OR MOISTURE!**

## **CAUTION**

**TO PREVENT ELECTRIC SHOCK DO NOT USE THIS  
(POLARIZED) PLUG WITH AN EXTENSION CORD,  
RECEPTACLE OR OTHER OUTLET UNLESS THE BLADES  
CAN BE FULLY INSERTED TO PREVENT BLADE EXPOSURE.**

## **ATTENTION**

**POUR PREVENIR LES CHOCS ELECTRIQUES NE PAS  
UTILISER CETTE FICHE POLARISEE AVEC UN  
PROLONGATEUR. UNE PRISE DE COURANT OU UNE AUTRIE  
SORTIE DE COURANT, SAUF SI LES LAMES PEUVENT ETRE  
INSEREES A FOND SANS EN LAISSER AUCUNE PARTIE A  
DECOUVERT.**

# TABLE OF CONTENTS

## Section 1 General Information

1.1	Introduction/Purpose of Equipment .....	1-1
1.2	Features .....	1-1
1.3	Service Policies .....	1-1
1.4	Glossary of Terms .....	1-2

## Section 2 Specifications and Performance

2.1	General Specifications .....	2-1
2.2	Monaural Specifications .....	2-1
2.3	Stereo Specifications .....	2-2
2.4	Performance Graphs .....	2-2

## Section 3 Installation and Operation

3.1	Unpacking .....	3-1
3.2	Accessories Supplied .....	3-1
3.3	Mounting .....	3-1
3.4	Operating Precautions .....	3-1
3.5	Controls and Adjustments .....	3-2
3.6	Connecting AC Power .....	3-2
3.7	Connecting Input/Output Lines .....	3-4
3.8	Mono Operation .....	3-5
3.9	Protection Mechanisms .....	3-7
3.10	Load Protection Methods .....	3-7
3.11	Cleaning .....	3-8

## Section 4 Technical Information

4.1	General Information .....	4-1
4.2	Block Diagram Circuit Theory .....	4-1

# LIST OF ILLUSTRATIONS

Fig. 1.1	Power Line Two Stereo Amplifier .....	1-1
Fig. 2.1	Nominal Crosstalk .....	2-2
Fig. 2.2	Nominal Output Impedance .....	2-3
Fig. 2.3	Nominal Damping Factor .....	2-3
Fig. 2.4	Nominal Noise Spectrum .....	2-4
Fig. 2.5	Nominal Phase Spectrum .....	2-4
Fig. 2.6	Nominal Power Efficiency .....	2-5
Fig. 2.7	Frequency Response .....	2-5
Fig. 2.8	Output Phase Angle .....	2-6
Fig. 3.1	Mounting Dimensions .....	3-2
Fig. 3.2	Power Line Two Front Panel .....	3-3
Fig. 3.3	Power Line Two Rear Panel .....	3-3
Fig. 3.4	Typical Stereo Hookup .....	3-4
Fig. 3.5	Banana (MDP) Plug .....	3-5
Fig. 3.6	Source Resistance and Damping Factor vs. Length and Size of Output Leads .....	3-6
Fig. 3.7	Typical Mono Hookup .....	3-6
Fig. 3.8	Fuse Selector Nomograph for Loudspeaker Protection .....	3-7
Fig. 3.9	Relay Controlled Protector with Overload Indicator .....	3-8
Fig. 4.1	Power Line Two Block Diagram .....	4-2



## SECTION 1 GENERAL INFORMATION

### 1.1 Introduction/Purpose of Equipment

The Crown® Power Line Two is a single or dual channel power amplifier designed for use in high quality audio systems. Even though its cosmetic appearance and internal design make it an ideal match for the Crown Straight Line Two preamplifier, the Power Line Two will work with most other conventional preamplifiers as well. To familiarize yourself with its many features, we recommend studying this manual thoroughly. We also suggest at this time that you pay special attention to the Crown warranty which will help to assure your total satisfaction with the Power Line Two (Fig. 1.1).

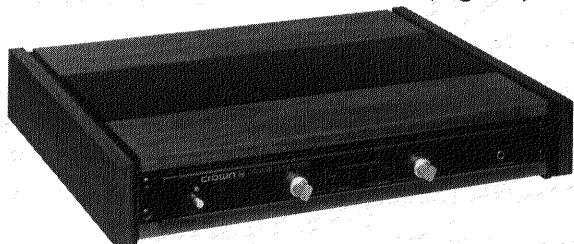

*Fig. 1.1 Power Line Two Stereo Amplifier*

### 1.2 Features

The Power Line Two is a medium-power amplifier (50 watts/channel into 8 ohms) for precision amplification from 20Hz-20KHz. As has become tradition with Crown amplifiers, it boasts extremely low harmonic, intermodulation and TIM distortion characteristics.

Designed to be mounted in a 1 3/4" standard rack space, the Power Line Two takes less space per rack/watt than most other comparable wattage amplifiers.

Total protection against shorted, mismatched or open loads is provided as well as protection against overloaded power supplies, chain destruction phenomena, input and high frequency overload. In addition, a thermal sensing circuit shuts down the AC line in case of overheating.

Input level controls for each channel are detented with 31 positions for exact "resetability" and more accurate control.

An amber power indicator and a pushbutton switch help determine the unit's power status at a glance.

Dual channel IOC™ circuitry (see glossary of terms) and Signal Presence indicators allow visible output signal monitoring.

High quality pin jacks are incorporated on the rear panel for receiving an input signal along with MDP banana type jacks for speaker connection. Banana jacks are mounted in such a manner as to make mono connection simple (see Section 3.8).

An external Mono/Stereo slide switch provides quick and easy conversion for determining the Power Line Two's operating status as a single or dual-channel amplifier.

The output transistor circuitry operates in the Crown designed, Multi-Mode™ configuration where at low listening levels, it functions as a Class A circuit, at medium power levels Class A plus B and at high levels, a Class AB+B. At each level, the Crown Multi-Mode™ circuit offers optimum performance and extremely low distortion (see Section 4.2 for further detail).

A front panel output monitor jack is provided not only for headphone use, but also as an additional output source should it be necessary.

### 1.3 Service Policies

Due to the sophisticated circuitry of your unit, only qualified, fully trained technicians should be allowed to service it. Please observe the following label on the unit: **CAUTION: TO PREVENT ELECTRIC SHOCK DO NOT OPEN. NO USER SERVICEABLE PARTS INSIDE. REFER SERVICING TO A QUALIFIED TECHNICIAN.**

For service, return the unit to the factory in the original packing or in replacement packing obtainable from the Crown factory. For warranty service, the unit must be returned to the factory or an approved service station (Amcron customers consult your local representative). In

either case, fill out and enclose the Service Information form located at the rear of this manual. This will help to ensure a speedy and effective response.

Crown will pay shipping costs (in the U.S.) for warranty service upon receiving copies of all shipping receipts.

Before returning your unit to the factory for service, authorization should be obtained from the Crown Technical Service Department. All shipments should be sent UPS or truck freight (insured). The factory will then return your serviced unit by one of the above methods.

Upon receipt of the warranty registration card from your dealer, Crown will register your unit on our computer warranty file.

Retain your copy of the bill of sale from your Crown dealer. This is your proof of purchase.

When you need service for your unit from an authorized Crown Service Station, simply present your bill of sale. With it, the service station can promptly initiate any needed paperwork. It will save you time and effort.

The bill of sale is also your proof of ownership should you need it for insurance or legal reasons.

## 1.4 Glossary of Terms

**A-B Test:** Evaluating relative performance of two (or more) components or systems by changing quickly from one to the other. Most high fidelity dealers have A-B test facilities.

**AGC:** Automatic Gain Control. A type of circuit used to maintain the output volume of a receiver constant, regardless of variations in the signal strength applied to the receiver.

**Attenuation:** A decrease in signal magnitude from one point to another, or the process causing this decrease.

**Balanced Input:** A three wire input system where the voltages and currents in two of the wires are equal in magnitude but opposite in polarity with respect to ground which is the third wire. The impedance of a balanced input is usually low. (600 ohms or less)

**Balun:** A device used for the transformation from an unbalanced line or system to a balanced line or system, or vice versa. The term is derived from balance to unbalance transformer.

**Bandpass Filter:** A filter that allows transmission of alternating signals whose frequencies are between given upper and lower cutoff values, while substantially attenuating all frequencies outside this band.

**Biamp:** The use of independent amplifiers to feed the bass and treble portions of a loudspeaker or loudspeakers with a crossover network. The purpose is to help reduce

intermodulation between bands when a system is overloaded. It also reduces the cost of implementing good, low loss precision crossover networks.

**Butterworth Filter:** A filter that exhibits the flattest possible response in the passband. The response rolls off smoothly into the stop band, where it approaches a constant slope of  $6n$  db/octave; where  $n$  is the number of poles in the network, i.e. a single pole is 6dB, two pole 12dB, 3 pole 18dB, etc.

**Capture Ratio:** The ability of a receiver to reject a weaker station whose frequency is the same as that of the desired station. This measurement will be in dB. The smaller the figure, the better the spec.

**Ceramic Filter:** A bandpass filter using a piezoelectric substrate material.

**Channel:** A channel is a complete sound path. A single channel, or monophonic system, has one channel. A stereophonic system has at least two full channels designated as left (A) and right (B). Monophonic material may be played through a stereo system; both channels will carry the same signal. Stereo material, if played on a monophonic system, mixes and emerges as a monophonic sound.

**Channel Separation:** Specified in dB, channel separation is the ratio of the measurable output of one channel to the unwanted output of the (undriven) opposite channel.

**Clipping:** The truncation of peaks of a signal due to exceeding the operating range of an electronic circuit. Normally, it refers to the result of voltage limitations in the circuit.

**Corner Frequency:** The frequency at which a filter goes from a condition of passing the signal unattenuated to "rolling off" or attenuating the signal according to its frequency. It is sometimes referred to as the "cutoff" frequency or the "break" frequency. It is also defined as 3dB below the unattenuated output level of the signal.

**Cross Modulation:** In FM signals, a type of intermodulation that occurs when the carrier of the desired signal is modulated by an undesirable signal. Each signal is of independent origin.

**Crossover Frequency:** The frequency at which a dividing network delivers equal power to the upper and lower frequency channels when both are terminated in specified loads.

**Crossover Network:** A selective network used to divide the audio frequency output of an amplifier into two or more bands of frequency. The band below the crossover frequency is fed the woofer loudspeaker while the high frequency band is fed to the tweeter. Also called dividing network and loudspeaker dividing network.



**Crosstalk:** Signal leakage from one signal source into another.

**Damping:** Controlling of vibrations, response, or resonances which if unchecked, would cause coloration of the sound.

**Damping Factor:** A numerical indication of an amplifier's ability to decrease unwanted loudspeaker movements. Damping factor can be found by dividing the load impedance by the amplifier's output impedance.

**Decibel:** A numerical expression of acoustic or electrical ratios, such as the relative intensity of a sound or the relative strength of a signal. One (dB) is about the smallest change in sound perceptible to the ear.

**Decoder:** A matrix of logic elements that selects one or more output channels according to the combination of input signals present. Can be used in FM to recover stereo signals of a stereo encoded multiplex transmission.

**De-emphasis:** In FM signals, restoring the pre-emphasized (for proper transmission characteristics) signal to result in a "flat" frequency response curve.

**Distortion:** Unwanted noise, or sounds which didn't exist in the studio when the original recording was made. Harmonic distortion produces tones harmonically related to a single, pure tone. Intermodulation distortion (IM) introduces new tones caused by mixing of two or more original tones. Phase distortion, or non-linear phase shift, disturbs timing sequence between a tone and its related overtones. Distortion which creates new spectra are expressed in percentages and phase distortion in degrees of phase shift or seconds of group delay vs. frequency errors.

**Dynamic Range:** The difference between the most intense and the least intense levels in a sound system.

**Equalization:** Frequency response manipulation to meet the requirements of recording, and an inverse manipulation on playback to restore the original. Also known as compensation for acoustic problems of listening rooms.

**Feedback:** Sending a "part" of a system's output back to the input. Positive feedback may lead to unstable conditions such as PA system "howling" due to sound from the speakers being fed back thru the microphone

and amplified again. Another form is low frequency interference created when vibrations from loudspeakers are picked up by the cartridge and amplified again. However, carefully controlled negative feedback in electronic circuits can be used to help reduce distortion and control stability.

**Flutter:** Rapid variation in the speed of a turntable or tape transport. Flutter causes a wavering of musical pitch.

**Frequency Response:** This term indicates any amplitude variations in a system output signal with respect to frequency. This measurement is made with a constant level input signal.

**Gain:** The ratio of an amplifier's output voltage to its input voltage.

**Headroom:** Stated in dB, headroom is the difference between the signal level and the limits of the sound system ie; the ratio of power available to power used.

**Hertz:** As in cycles-per-second, not rental agency.

**High Pass/Low Pass Filter:** High pass - a filter having a single transmission band extending from some critical, or cutoff, frequency other than zero, up to infinite frequency. Low pass - a filter network which passes all frequencies below a specified frequency with little or no loss but discriminates strongly against higher frequencies.

**IF:** An Intermediate Frequency is a frequency to which a signal wave is shifted locally as an intermediate step in FM transmission or reception.

**Image Response:** Response of a superheterodyne receiver to the image frequency, as compared to the response to the desired frequency.

**Input Sensitivity:** The input voltage required to drive an amplifier to its rated output.

**IOC™:** Stands for Input-Output Comparator. An extremely sensitive Crown circuit used to indicate, via a front panel LED, the fact that the operating limits of an amplifier are being exceeded resulting in output non-linearity.

**LED:** Light Emitting Diode. A PN junction that emits light when biased in the forward direction.

**Limiters:** A circuit in which the output amplitude is substantially linear with regard to the input up to a pre-determined value and substantially constant thereafter.

**Load:** A device that absorbs power and converts it into the desired form.

**LSI:** Large Scale Integration is an integrated circuit chip housing a large number of active devices.

**Mixer:** A device having two or more inputs, usually adjustable, and a common output, which operates to combine linearly in a desired proportion the separate input signals to produce an output signal.

**Monitoring Amplifier:** A power amplifier used primarily for evaluation and supervision of a program.

**Multipath Delay:** In FM the existence of more than one signal path between transmitter and receiver. The two signals arriving at different times causes distortion.

**Music Power:** This rating expresses the ability of an amplifier to handle short duration power peaks, as opposed to sustained power levels. An amplifier may only be capable of putting out 45 watts if that level is continuous, but it may be able to handle 60 watt peaks (such as might occur in a musical passage), if the peaks do not last too long.

**Muting Circuit:** In FM, a circuit which cuts off the receiver output when the r-f carrier reaching the first detector is at or below a pre-determined intensity.

**Pre-emphasis:** A process in a system designed to emphasize the magnitude of some frequency components with respect to the magnitude of others, to reduce adverse effects, such as noise, in subsequent parts of the system.

**PLL:** Phase Lock Loop; a circuit for synchronizing a variable local oscillator with the phase of a transmitted signal. Can be used in FM as a synthesizer circuit as well as a stereo decoder in the multiplex system.

**Polar Curve:** A pattern used to show the directional characteristics of antennas, microphones or speakers.

**Quartz Crystal:** A complete assembly, comprising a piezoelectric quartz-crystal element mounted, housed, and adjusted to the desired frequency. Such a device is commonly employed for purposes of frequency control, frequency measurement and electric wave filtering.

**Rotor:** A motor driven assembly which turns an antenna so that it can be aimed in the direction of best reception.

**SAW Filter:** Surface Acoustic Wave; commonly used as a bandpass filter. Device transmits surface acoustic waves on a piezoelectric substrate. Used in the FMI for low FM distortion.

**Selectivity:** In FM a measure of the extent to which a receiver is capable of differentiating between the desired signal and disturbances at other frequencies.

**Sensitivity:** A receiver specification indicating the smallest input signal strength required to produce an output signal whose characteristics are standardized and used as a reference.

**Signal:** A visible, audible or other conveyor of information.

**Signal-To-Noise-Ratio:** Measured in dB, signal to noise ratio is a relative term meaning the ratio between the desired output signal and the interference or noise. A typical figure would be 60dB which stands for a ratio of 1000-1.

**Superheterodyne:** A method of receiving radio waves in which the process of heterodyne reception is used to convert the voltage of the received wave into a voltage of an intermediate, but usually superaudible frequency, that is then detected.

**Synthesizer:** A Phase Lock Loop (PLL) system which constructs an oscillator signal by phase locking it to a reference times (X) the ratio of two integers (reference is usually a quartz crystal oscillator).

**Triamp:** The use of three separate amplifiers to drive the high, middle and low frequency sections of a speaker system.

**Varactor:** A two terminal semiconductor device in which the electrical characteristic of primary interest is a voltage-dependent capacitance. Used in FM tuner inputs for voltage controlled timing.

**Wow:** Distortion caused in sound reproduction by slow variation in speed of the turntable or tape. (See flutter.)





## SECTION 2

# SPECIFICATIONS AND PERFORMANCE

### 2.1 General Specifications

**Hum and Noise:** From 20Hz-20KHz the hum and noise level is below 75 microvolts and 110dB below the rated output.

**Phase Response:** +10°, -15° 20Hz - 20KHz at 1 watt.

**Input Impedance:** 25K ohm, ±30%.

**Amplifier Output Protection:** Total protection against shorted, mismatched or open outputs. Volt-ampere limiting circuitry acts instantaneously with no annoying thumps or cutouts.

**Overall Protection:** AC line fused. Thermal switch in control logic protects against overheating caused by insufficient ventilation. Controlled slewing rate voltage amplifiers protect overall amplifier against RF burnouts. Input overload protection is furnished by internal resistance at inputs of amp.

**DC Output Offset:** (shorted input) ±10 millivolts.

**Turn On:** With minimum thumps; 4 second delay.

**Power Supply:** A specially designed low profile transformer plus computer grade filter capacitors serve to power the Power Line Two.

**Power Requirements:** AC voltages of 100, 120, 200, 220, and 240 volts ±10% at a line-frequency between 50 and 400Hz may be used.

**Power Consumption:** 15 watts while at idle, 200 watts at the full rated output.

**Heat Sinking:** The entire amplifier is used as a heat sink. Heat generated from the output stage is dissipated through the chassis, thermally coupled with an efficient aluminum heat exchanger.

**Chassis:** Aluminum-chassis construction for maximum heat conduction and minimum weight. Steel top cover for added electromagnetic shielding.

**Controls:** Two input-level controls and a power switch on the front panel. A mono-stereo switch is located on the rear panel.

**Indicators:** 2 IOC indicators (red); 2 signal-presence indicators (green); 1 power indicator (amber).

**Connectors, Input:** Standard unbalanced pin jacks.

**Output:** Color-coded binding posts with a ¼" stereo Output Monitor jack on the front panel. (Note: Output Monitor jack is connected directly in parallel with the binding posts.)

**Dimensions:** 19 inch (48.3cm) standard rack mount, 1¾" (4.4cm) high and 11½" (29.2cm) deep from mounting surface of front panel.

**Weight:** Approximately 15 pounds (6.8kg) net weight.

**Finish:** Two finishes are available: a black polyester vinyl coated aluminum front panel (shown in this manual) or brushed and satinized aluminum front panel.

### 2.2 Monaural Specifications

**Output Power (8 ohms):** 125 watts minimum RMS into an 8 ohm load over a bandwidth of 20Hz-20KHz at a rated RMS sum total harmonic distortion of 0.05% of the fundamental output voltage.

**Output Power (16 ohms):** 100 watts minimum RMS into a 16 ohm load over a bandwidth of 20Hz-20KHz at a rated RMS sum total harmonic distortion of 0.05% of the fundamental output voltage.

**Frequency Response:** +0.0, -2dB 20Hz-20KHz, 1 watt, 16 ohms. +0.0, -1.2dB 5Hz-50KHz, 1 watt, 16 ohms.

**1KHz Power:** 110 watts RMS into 16 ohms; 145 watts RMS into 8 ohms, (0.1% Total Harmonic Distortion).

**Harmonic Distortion:** Less than 0.001% from 20Hz-400KHz and increasing linearly to 0.05% at 20KHz at 100 watts into 16 ohms.

**I.M. Distortion:** Less than 0.05% from 0.02 watts to 0.25 watts, and less than 0.01% from 0.25 watts to 100 watts into 16 ohms.

**Slewing Rate:** 16 volts per microsecond.

**Damping Factor** Greater than 400, DC-400Hz into 16 ohms.

**Output Impedance:** Less than 30 milliohms in series with less than 6 microhenries.

**Load Impedance:** Rated for 8 and 16 ohm usage, safely drives any load including completely reactive loads.

**Voltage Gain:**  $41.2 \pm 2\%$  (or  $32.3 \pm 0.2\text{dB}$ ) at maximum gain.

**Mono Input Sensitivity:** .970 volts  $\pm 2\%$  for 100 watts into 16 ohms.

**Mono Output Signal:** Balanced, single channel. Channel 1 controls are active, Channel 2 is fully CCW, but not cut out.

**Stereo Input Sensitivity:** .970 volts  $\pm 2\%$  for 50 watts into 8 ohms.

**Stereo Output Signal:** Unbalanced, dual channel.

## 2.3 Stereo Specifications

**Output Power (4 ohm):** 60 watts per channel minimum RMS (both channels operating) into a 4 ohm load over a bandwidth of 20Hz-20KHz at a rated RMS sum total harmonic distortion of 0.05% of the fundamental output voltage.

## 2.4 Performance Graphs

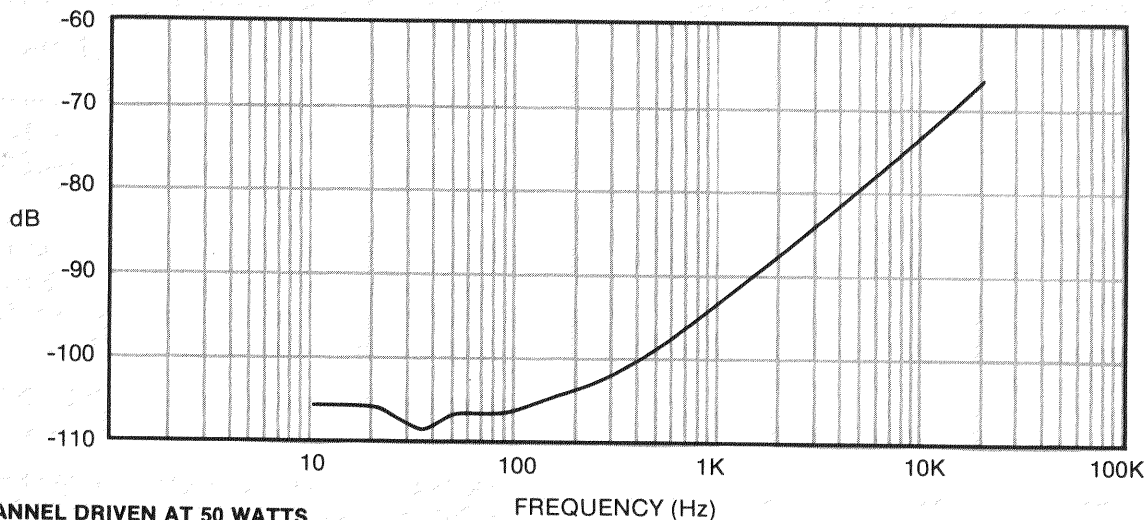

ONE CHANNEL DRIVEN AT 50 WATTS  
1K OHM TERMINATOR USED ON NON-DRIVEN INPUT

Fig. 2.1 Nominal Crosstalk

**Output Power (8 ohm):** 50 watts per channel minimum RMS (both channels operating) into an 8 ohm load over a bandwidth of 20Hz-20KHz at a rated RMS sum total harmonic distortion of .05% of the fundamental output voltage.

**Frequency Response:** +0.0, -2dB 20Hz-20KHz at 1 watt into 8 ohms. +0.0, -2.0dB 5Hz-100 KHz at 1 watt into 8 ohms.

**1KHz Power:** 55 watts RMS into 8 ohms, per channel, both channels operating, 0.1% total harmonic distortion; 70 watts RMS into 4 ohms, per channel, both channels operating, 0.1% total harmonic distortion.

**Harmonic Distortion:** Less than 0.001% from 20Hz-400Hz, and increasing linearly to .025% at 20KHz at 50 watts RMS per channel into 8 ohms.

**I.M. Distortion (60Hz-7KHz 4:1):** Less than 0.02% from 0.01 watts to 0.25 watts, and less than 0.01% from 0.25 watts to 50 watts into 8 ohms per channel.

**Slewing Rate:** 8 volts per microsecond.

**Damping Factor:** Greater than 400, DC-400Hz into 8 ohms.

**Output Impedance:** Less than 15 milliohms in series with less than 3 microhenries.

**Load Impedance:** Rated for 8 and 4 ohm usage; safely drives any load including completely reactive loads.

**Voltage Gain:**  $20.6 \pm 2\%$  or  $26.3 + 0.2\text{dB}$  at maximum gain.

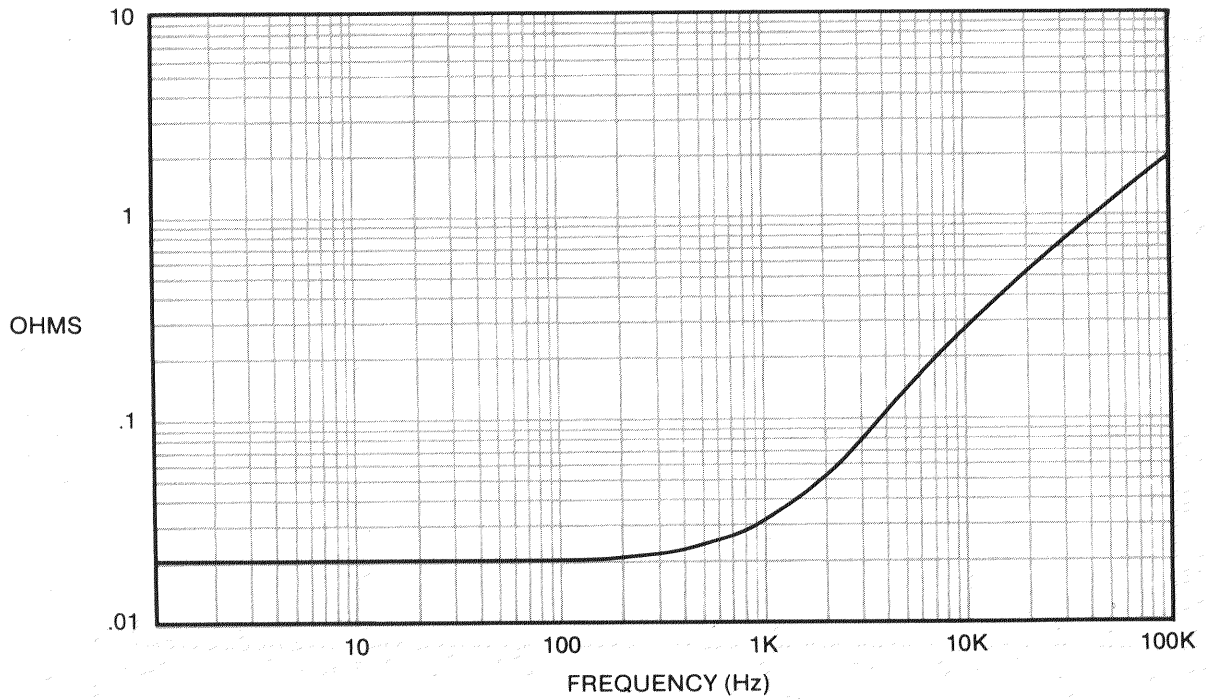

*Fig. 2.2 Nominal Output Impedance*

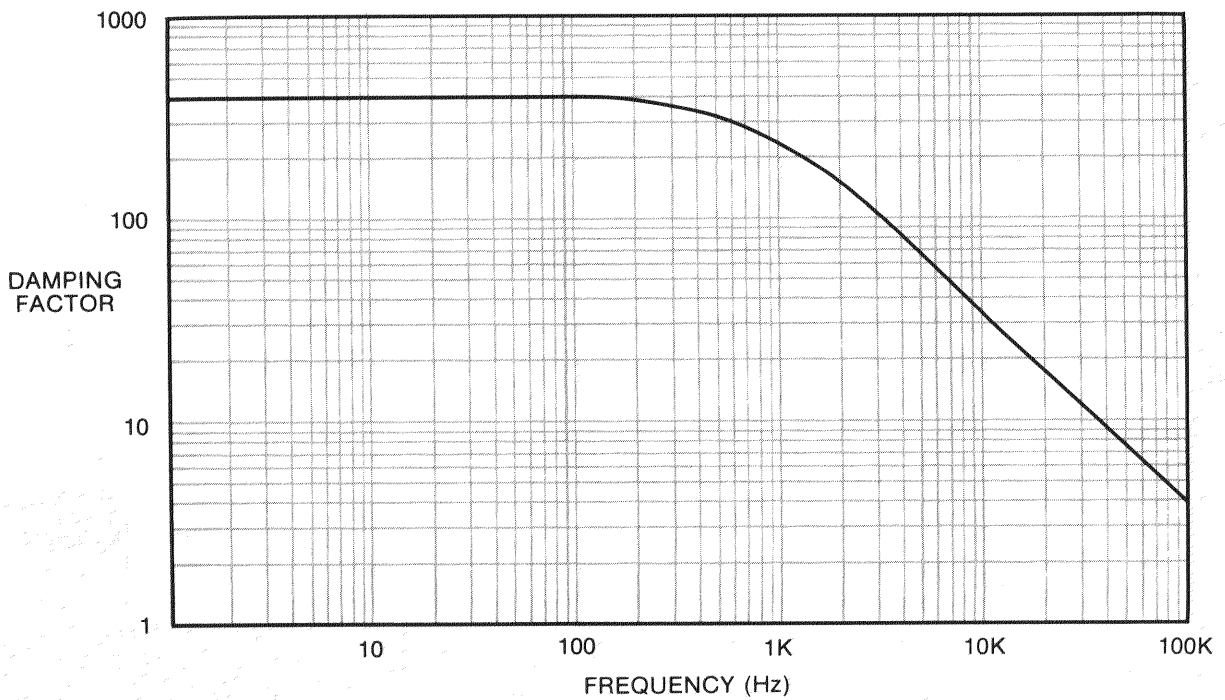

*Fig. 2.3 Nominal Damping Factor*

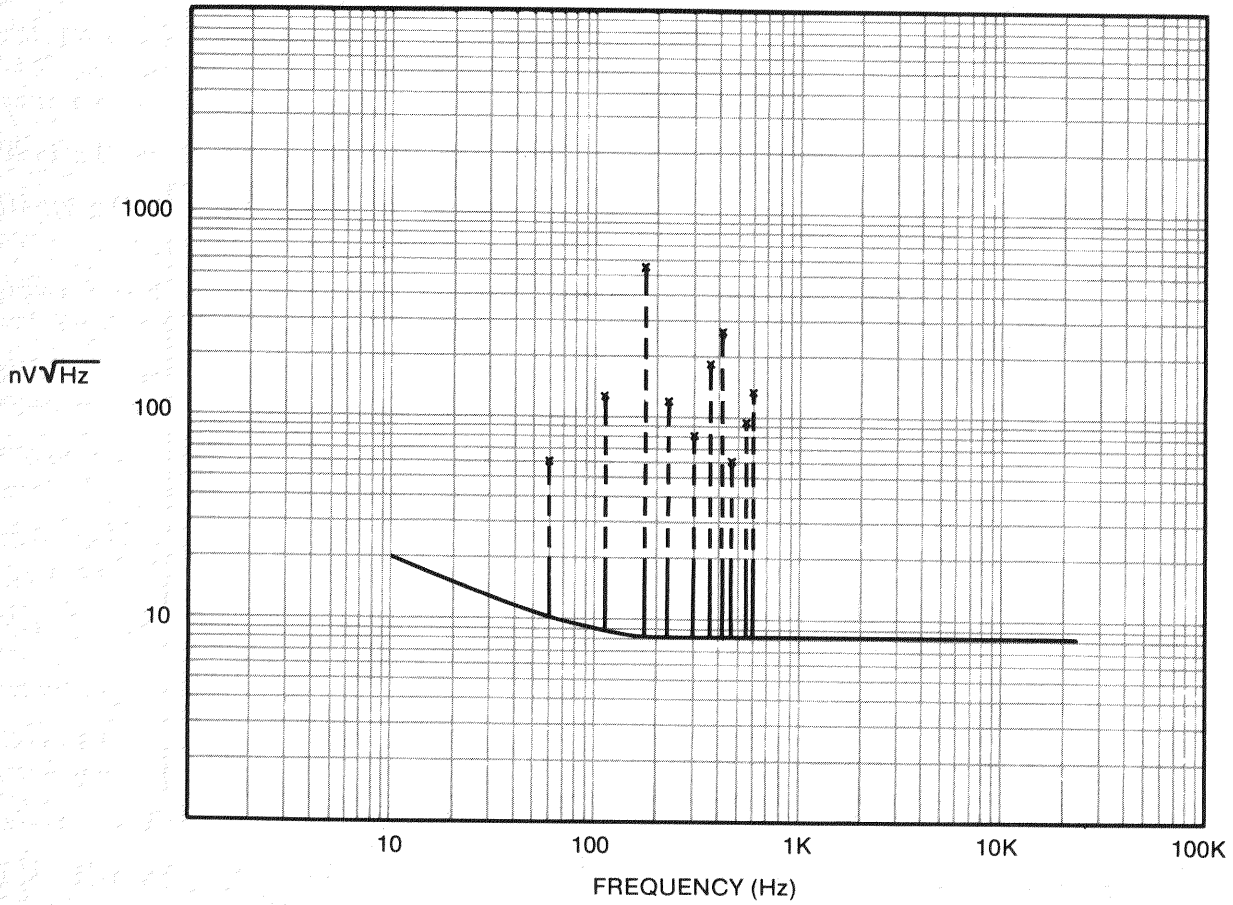

LINE FREQUENCY HARMONICS PLOTTED TO THE TENTH  
OUTPUT IS INDICATED BY (X) ON EXTENDED DOTTED LINES

Fig. 2.4 Nominal Noise Spectrum

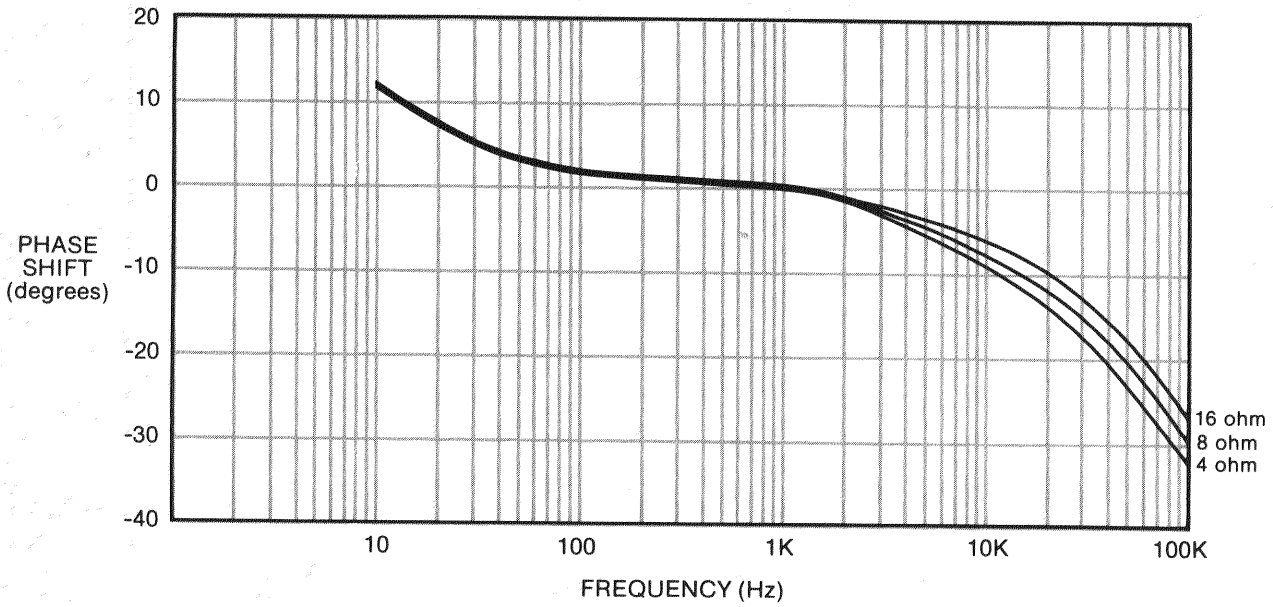
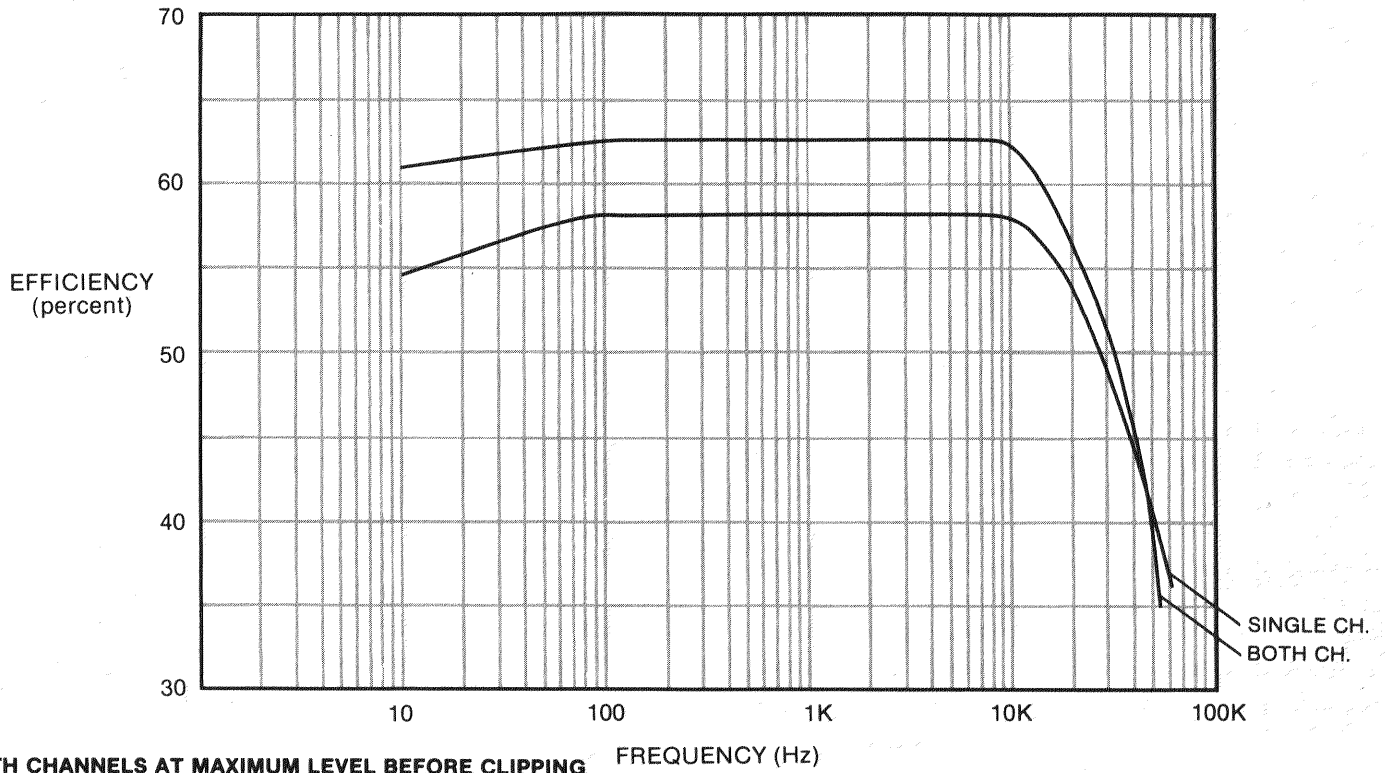
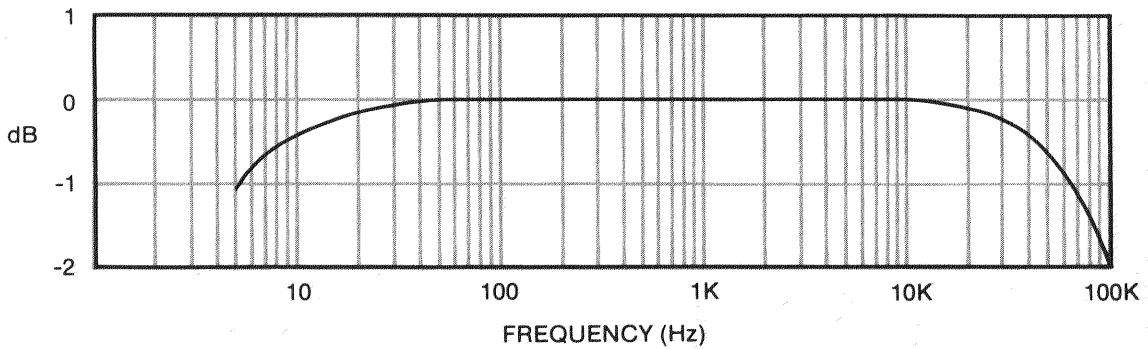

Fig. 2.5 Nominal Phase Spectrum



*Fig. 2.6 Nominal Power Efficiency*



*Fig. 2.7 Frequency Response*

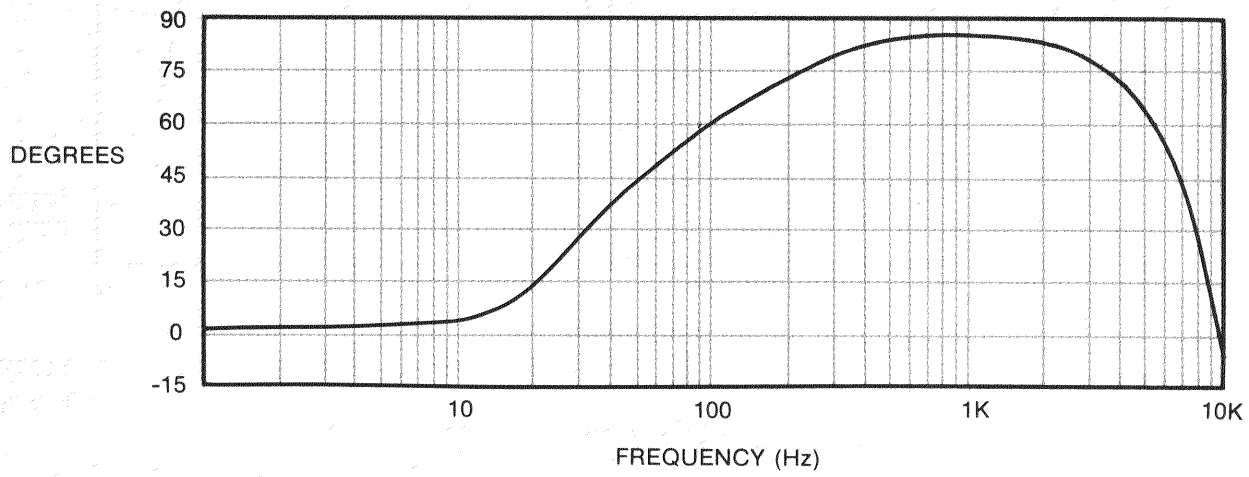

*Fig. 2.8 Output Phase Angle*



## SECTION 3 INSTALLATION AND OPERATION

### 3.1 Unpacking

As soon as the unit is received, please inspect for any damage incurred in transit. Since the unit was carefully inspected and tested at the factory, it left unmarred. If damage is found, notify the transportation company immediately. Only the consignee may institute a claim with the carrier for damage during shipment. However, Crown will cooperate fully in such an event. Be sure to save the carton as evidence of damage for the shipper's inspection.

Even if the unit arrived in perfect condition, as most do, it is advantageous to save the packing materials. They will prove valuable in preventing damage should there ever be occasion to transport or ship the unit. Note the carton and internal pack - each is designed for protection during transit. **DO NOT SHIP THE UNIT WITHOUT THIS FACTORY PACK!**

### 3.2 Accessories Supplied

The Power Line Two comes complete with:  
One Instruction Manual  
One Accessory Kit including:

- 2 MDP banana plugs
- fuses and fuse holders
- 2 wire nuts
- 2 pin to pin cables
- 4 nylon thumb screw washers
- 4 10-32x.75 thumb screws

### 3.3 Mounting

The Power Line Two may be mounted in either a Crown walnut cabinet (other hardwoods available upon request) or a customized cabinet of your own design. In each case, standard 19" width spacing should be utilized as shown in Fig. 3.1. In most situations, use of vented panels in the top and bottom of the outside cabinet will be adequate ventilation for the Power Line Two.

### 3.4 Operating Precautions

The following are a number of operating precautions given as an aid to understanding proper and improper amplifier usage:

1. Use care in making connections, selecting signal sources, and controlling the output level. The load you save may be your own. Crown is not liable for any damage done to loads, i.e., careless amplifier usage or deliberate overpowering. For pointers on load protection see Section 3.
2. Never parallel the output with any other amplifiers output. Such connection does not result in increased power output. Damage incurred by such operation is not covered under warranty.
3. Never drive a transformer-coupled device or any other device which appears as a low frequency short (less than 3 ohms at DC) without a series isolating capacitor. Such operation may damage the device and/or needlessly waste output power.
4. Do not short the ground lead of the output cable to the input signal ground as oscillations may result from forming such a loop.
5. Never remove covers!
6. Operate the amplifier from AC mains of not more than 10% above or below the selected line voltage and only 50/60Hz AC. Failing to comply with these frequency limits also invalidates the warranty.
7. Never connect the output to a power supply output, battery, or power main.
8. Tampering in the circuitry by unqualified personnel or the making of unauthorized circuit modifications invalidates the warranty.

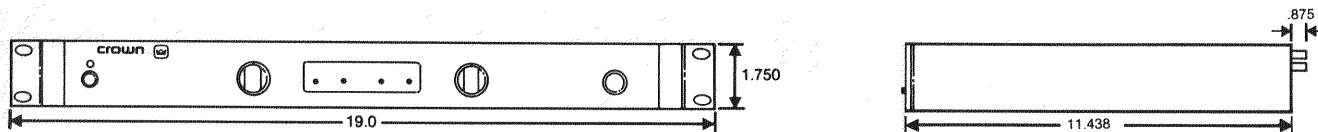

Fig.3.1 Mounting Dimensions

### 3.5 Controls and Adjustments

The Power Line Two front panel (Fig. 3.2) consists of an AC power switch, a left and right channel Input Level control and a pair of IOC™ (Input/Output Comparator) and Signal Presence indicators.

The AC power switch is a two position (on/off) pushbutton-type control located at the lower left of the unit. When the switch is depressed, an amber indicator light will illuminate to signify that the unit is properly powered.

Both input level controls are detented with thirty-one positions. This provides more accurate control of the signal as well as the ability to adjust the input level to a previously desired setting with identical results. These detents also help in preventing accidental movement of the controls should they be bumped or jarred.

Green Signal Presence indicators should be used in conjunction with the IOC™ indicators in adjusting the input level controls. As the Input Level controls are increased, Signal Presence indicators will illuminate continuously and should remain so when the desired operating level is obtained. Increasing the level controls even further will eventually cause the IOC™ indicators to glow. At this point the input signal is too high and should be lowered back to the point where the Signal Presence indicators still glow and the IOC indicators only flash occasionally (this procedure is with audio information applied).

A standard ¼" Output Monitor jack is provided for connection of 8 ohm or higher impedance stereo headphones. This jack may also be used as another source of output signal for an additional external device.

On the Power Line Two rear panel (Fig 3.3), a pair of banana jacks are utilized to supply a path for the output signal to the speakers. Because of their spacing, the output jacks can easily provide a balanced, mono output signal (across the red terminals, see Section 3.8).

A Stereo/Mono slide switch determines whether the unit is to perform as a single (mono) or dual (stereo) channel amplifier.

Pin jacks provided accept the line-level unbalanced input signal from a preamplifier. Both jacks are used for a stereo setup but only the left channel jack for a mono setup.

### 3.6 Connecting AC Power

The Power Line Two is furnished with a two wire AC plug as standard equipment. Sound systems tend to function audibly better when the individual components are tied together only through their input and output cable ground rather than with both the AC ground and signal cable ground. The reason for this is because the chances for multiple ground paths or "loops" are greatly reduced. By supplying only a two wire AC plug with the Power Line Two, there is practically little or no opportunity for AC ground signals to form loops with the input signal grounds.

**Note:** Crown assumes no liability whatsoever for operation of ungrounded auxiliary equipment, nor for the violation of UL or electrical codes.

The Power Line Two may be connected for any of five operating voltages:

100, 120, 200, 220, and 240 VAC. Converting from one to another should be attempted by an experienced technician only. See your Crown dealer should alteration become necessary.



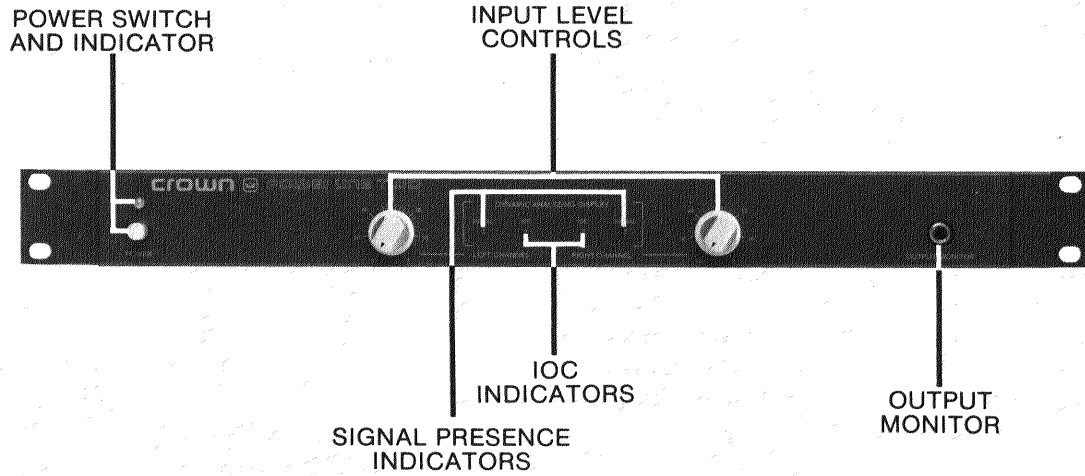

Fig. 3.2 Power Line Two Front Panel

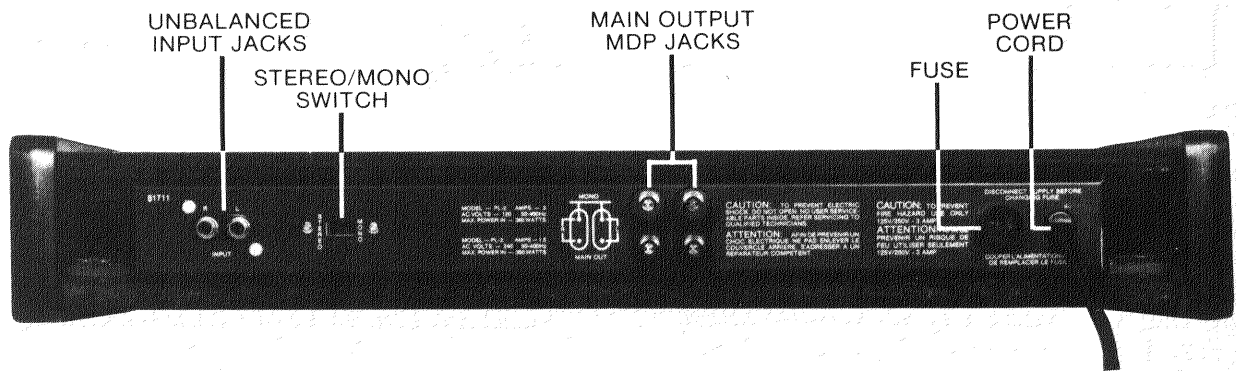

Fig. 3.3 Power Line Two Rear Panel

### 3.7 Connecting Input/Output Lines

Fig. 3.4 is a hook-up diagram that may be followed for most conventional systems. When connecting inputs, standard pin jack/plug configuration must be used from the preamplifier to the Power Line Two. The following are several hints that may be helpful when considering hook-up:

1. Only shielded cable should be used. The higher the density of the shield (the outer conductor) the better.
2. Use cables that are only as long as necessary. Avoid cables that are longer than 10 feet. Because the Power Line Two amplifier uses an unbalanced input signal line (two conductor, high impedance), cables longer than 10 feet may cause noticeable loss of high frequency information and/or audible interference pick-up from external sources.
3. Do not tie input signal cables together in the same bundle as speaker wires or AC cords. This greatly increases the chance of hum and noise picked up due to asymmetrical ground loops.

4. The Power Line Two is protected against DC or subsonic information fed to its inputs. However, the input should be free of as much of this type of information as possible in order to avoid exceeding the normal input protection limits of the amplifier and ultimately produce speaker damage. Most well-designed preamplifiers on the market today will operate successfully into the 25K input of the Power Line Two. If in doubt, contact the Crown Technical Service Department for assistance.

The Power Line Two output connectors are located on the rear of the unit as shown in Fig. 3.3. It is advisable to always remove power from the unit and turn the Input Level Controls down while making connection. This will help to eliminate any chance of a loud blast.

**NOTE: CROWN IS NOT LIABLE FOR DAMAGE INCURRED TO ANY TRANSDUCER DUE TO ITS BEING OVERPOWERED!**

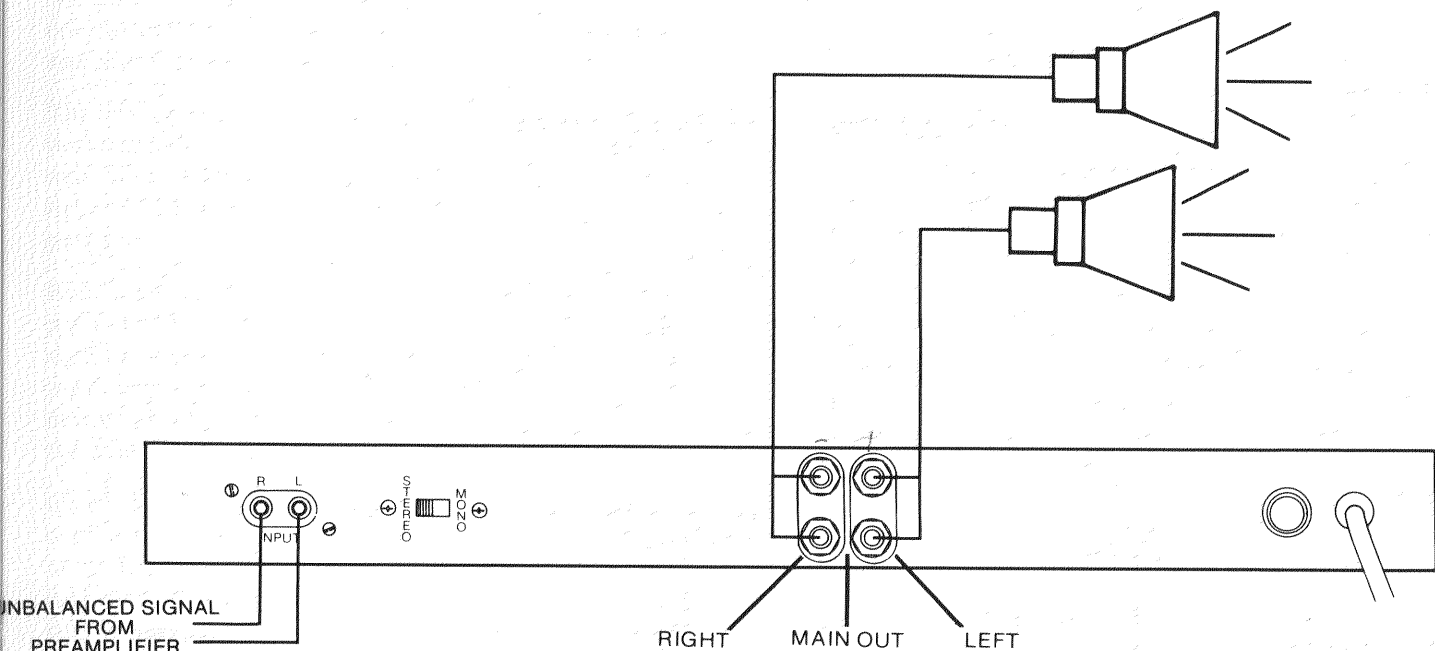
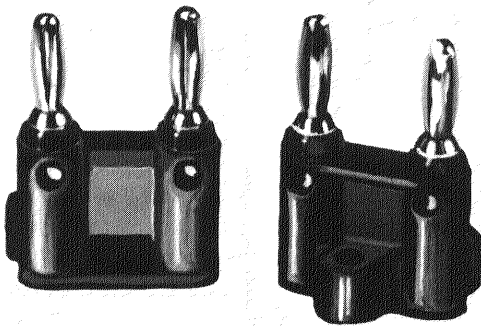

Fig. 3.4 Typical Stereo Hookup

Output connectors should be of such a type to reliably handle the units output signal. A recommended connector is the dual banana (MDP) plug (Fig. 3.5). Care should then be taken that the connector is kept "snug-fitting" as frequent plugging and unplugging loosens the joint. Also, because of the construction of the binding posts, it is possible to use tinned and twisted wire.



*Fig. 3.5 Banana (MDP) Plug*

The gauge and length of speaker cable is directly proportional to the resistance; as the wire diameter decreases (higher gauge number) and/or the length increases, the resistance rises. Because an increase in cable resistance effectively increases the source impedance of the amplifier (as seen by the speaker) the cable affects the damping factor (see glossary of terms). Fig. 3.6 is a nomograph which illustrates the relationship between load impedance, damping factor, wire gauge and length.

As can be seen from the example in Fig. 3.6, a 50 foot length of #12 AWG annealed copper wire (2 conductor speaker cable, 50 foot per conductor) yields a combined amplifier/cable source impedance of 0.16 ohms. Given a typical 8 ohm load impedance, this results in an effective damping factor of 50 (not the rated 400 that would be obtained were there zero ohms cable resistance). From this example, it can be seen that larger diameter (lower wire gauge number) wire, should be used for longer cables.

For dynamic moving-coil loudspeakers (as most are) the value of RL should be preferably that measured by an ohmmeter across the voice coil (speaker terminals) rather than the manufacturers rating. For electrostatic speakers

and such, the manufacturers rated impedance should be used for RL.

Output cables should always be carefully laced together so that large magnetic fields are not formed, resulting from current carrying loops. Such fields will often couple the input signal path and result in undesired feedback and oscillations. Of course the output cables should never be routed with the input cables for the same reason.

Amplifier input and output grounds should never be joined externally to the unit. Such a connection is almost always sure to form regenerative feedback and result in system oscillations. High frequency coupling between output signals and input grounds and signals is frequently difficult to eliminate. A common cause of this problem is capacitive coupling through the AC mains where the output and input signals are attached to AC powered devices. In some situations the only solution may be to place a low pass filter at the input to the amplifier.

### 3.8 Mono Operation

The Power Line Two may be operated as a mono (or single channel) amplifier with relatively little conversion effort. The mono/stereo slide switch on the rear panel determines the mode of the amplifier. When in the mono position, the input circuitry of the Power Line Two is altered so that the two channels amplifiers are "added" for additional output. Care must be taken in the external hook-up to assure proper operation. Observe the following:

1. Set the Stereo/Mono switch to mono.
2. Connect a single input line to left channel only.
3. Only the left channel Input Level Control should be used for adjusting the mono input level (right channel input jack and level control are not defeated in the mono mode). However, the right channel input jack **SHOULD NOT** be used. If right channel input is added to the left channel input, severe distortion may result. If the right channel input is used alone, a very low power output will result. For best performance, unplug the input to right channel and adjust its level control fully counterclockwise.

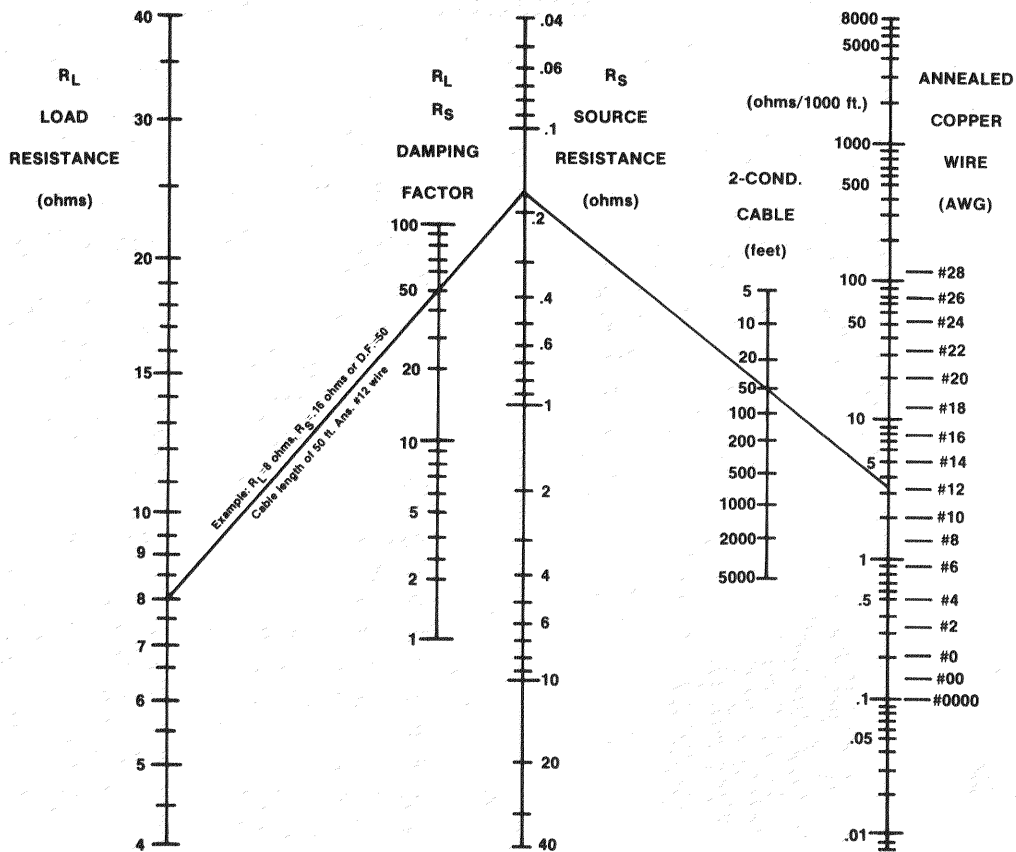

Fig. 3.6 Source Resistance and Damping Factor vs. Length and Size of Output Leads

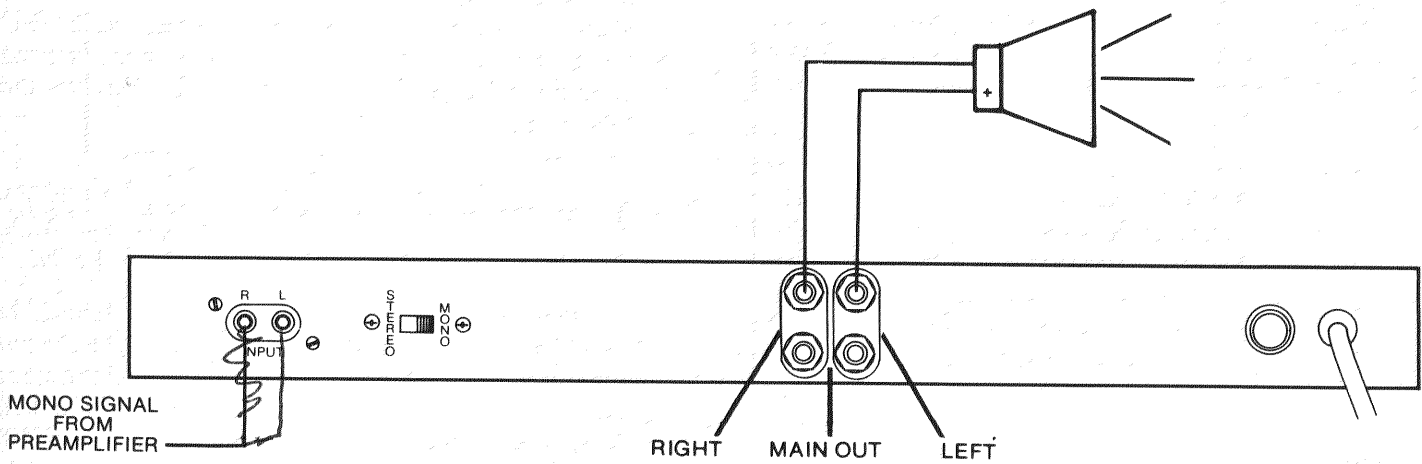

Fig. 3.7 Typical Mono Hookup

4. Connect the output lines as shown in Fig. 3.7. The output from the Power Line Two in mono is balanced and is isolated from the chassis and from the input grounds. Both leads are connected to the red or "hot" terminals only of the banana output jacks which are mounted such that only one double MDP plug is necessary for mono hook-up.

**Caution: Be certain that all equipment connected to the mono output lines (meters, switches, etc.) is balanced. Both sides of the line must be totally isolated from the input grounds to the power line two. If this is not observed, severe oscillation may result.**

5. Total speaker impedance should not be lower than 8 ohms in the mono mode. Should the speaker impedance go below 8 ohms, it is possible to activate the protection circuitry to the point of eventual thermal shut-off (power is removed from the unit).

### 3.9 Protection Mechanisms

The Power Line Two is protected against common hazards which plague power amplifiers, including shorted, open, and mismatched loads. Also, overloaded power supply, chain destruction phenomena, input overload damage and high frequency overload blowup protection is provided.

Protection against shorted and mismatched loads is supplied by a fast-acting limiter circuit group which instantaneously limits the output for the maximum safe-stress value of the output transistors.

If a speaker initiates protection in the amplifier, the audible effects range from something resembling crossover notch distortion to a snapping sound, depending on the overall load characteristics. Speaker systems which are truly 4 ohms or greater (for the stereo mode) will not initiate the protection circuitry.

All voltage-amplifier circuitry is designed to be inherently current limited. Thereby, if any of the devices should fail, no damage should occur to the rest of the stages.

The Input stage is protected against overdrive damage by a series limiting resistor should the input signal level ever become excessive. An AC coupled input section aids in preventing any DC or subsonic frequencies (under 20Hz)

from passing through the amplifier and damaging speakers.

Thermal protection is provided should the amplifier's internal operating temperatures exceed the safe operating area of the output devices. The unit will simply power down (shut off) until it has had ample time to dissipate the excess heat. After that time, the unit will return to normal operating status.

Controlled slewing-rate which coupled with the V-I limiter, protects the amplifier from blowups when fed large RF input signals.

### 3.10 Load Protection Methods

The most common of all load protection methods is a fuse in series with the load. The fuse may be single, fusing the overall system, or (in the case of multi-element speaker systems) may be multiple with one fuse on each speaker. Fuses help prevent damage due to prolonged overload, but provide essentially no protection against damage that may be done by large transients. To minimize this problem, high speed instrumentation fuses such as Littlefuse 36100 series are recommended. For a nomograph showing fuse size vs. loudspeaker ratings, refer to Fig. 3.8.

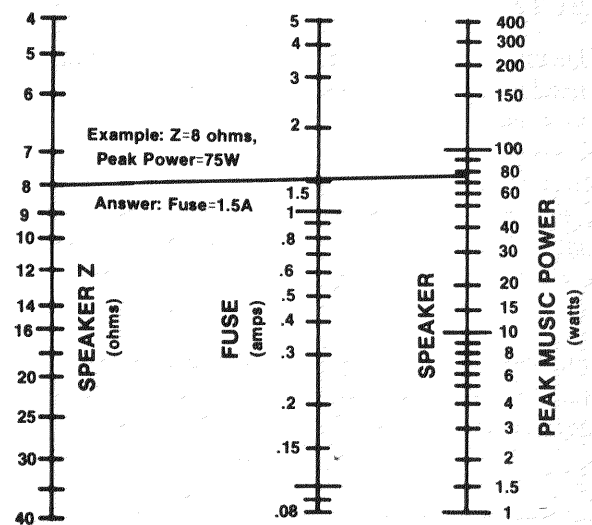

Fig. 3.8 Fuse Selector Nomograph for Loudspeaker Protection

Another form of load protection is shown schematically in Fig. 3.9. This circuit may be assembled with parts available from your local electronics shop. Whenever the load is overdriven, a relay switches a lamp in series with the load, smoothly relieving the overload. The lamp then doubles as an overdrive indicator as it glows. If overdrive is unreasonably severe, the lamp will serve as a fuse. By adjusting the relay tension and the protection level control, this system is useful from 25 to 200 watts for a typical 8 ohm load.

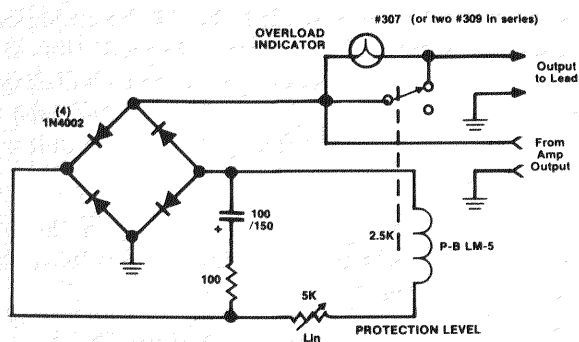

Fig. 3.9 Relay Controlled Protector with Overload Indicator

### 3.11 Cleaning

The Crown Power Line Two has a rugged front panel and will last a lifetime with moderate care. The panel can be cleaned with a moist cloth and mild detergent. Never use steel wool, scouring powder, lye solution, or any strong abrasive cleaner since these will damage the panel's finish. Avoid spray-on wax cleaners; if you must use a spray cleaner, apply it to a cloth and then wipe the Power Line Two panel.

The chassis should require no more cleaning than a periodic dusting with a clean, dry cloth.



## SECTION 4

# TECHNICAL INFORMATION

### 4.1 General Information

This section provides moderately technical information for those interested in the electrical operation of the Power Line Two. It is **not** service information and should therefore not be used as such. Always refer servicing to the Crown factory or a qualified Crown Service Center.

### 4.2 Block Diagram Circuit Theory

Refer to the block diagram in Fig. 4.1. The diagram does not show all circuit connections or feedback loops due to circuit complexity, but there is sufficient data to grasp the function of each circuit stage.

An unbalanced input signal is inserted to the rear panel pin jacks and varied in level with the Input Level Controls. The Signal is then fed to the IC op amp and main amplification stage where it is boosted to a level of sufficient amplitude to drive an output load.

The IOC™ circuitry works in conjunction with the error correcting signal of the main op amp. Any time a small “non-linearity” exists in the amplifier, an error signal appears at the output of the main op amp (via the feedback loop of the unit). This produces an abnormally high value, exceeding the “window” of the IOC™ and illuminating the LED. Since transient overload can happen rapidly, a pulse stretching circuit is added so the eye can detect the LED lighting.

Current amplification circuitry (otherwise known as the Crown \*Multi-Mode™ circuit) consists of basically three stages: the Predriver, the Driver and the Output transistor stage. With low level signals, the Multi-Mode™ circuit has been designed to function as a Class A circuit, with the drivers always biased on. This provides the optimum low distortion for which the Class A circuit is famous, but reserves its use only for the low-level situations for which it is optimum. When the signal asks the output to move into middle power ranges, the Multi-

Mode™ circuit immediately changes state to a “Class A plus B” mode in which the drivers continue to operate in Class A and are always on; but the output devices move smoothly into a Class B operation to provide the additional power needed to boost the output signal to the desired level.

Finally, at highest levels, the first and second stage drivers go into an AB mode, with divided responsibilities for positive and negative portions of the signal, with the third-stage output devices operating in Class B to develop the desired power.

At each level, the Crown Multi-Mode™ circuit thus offers optimum performance in terms of extremely low distortion (whether measured in music-type signals or with more traditional test signals) and in terms of circuit efficiency.

An additional portion of the output signal is fed to the Signal Presence Indicator circuitry. Provided the output signal has an amplitude of at least 1 volt peak-peak, a DC voltage will be applied to the green LEDs causing them to light.

In the mono mode, the stereo/mono switch applies the polarity reversed output of the left channel input amplifier to the input of the right channel amplifier. Since the two channels are fed with identical signals of reversed polarity, the outputs will be swinging in opposite directions, and a load connected across the hot terminals (+) of the two channels will see twice the voltage that would be obtained across the (+) and (-) terminals of either channel's output.

The continuous duty type Power Supply provides the proper voltages to the various sections of the amplifier. A bipolar 40 volt supply provides the power for the output stages.

\*For additional information on the Multi-Mode™ circuit request “A Crown White Paper, Theory and Operation of the Crown Multi-Mode™”.

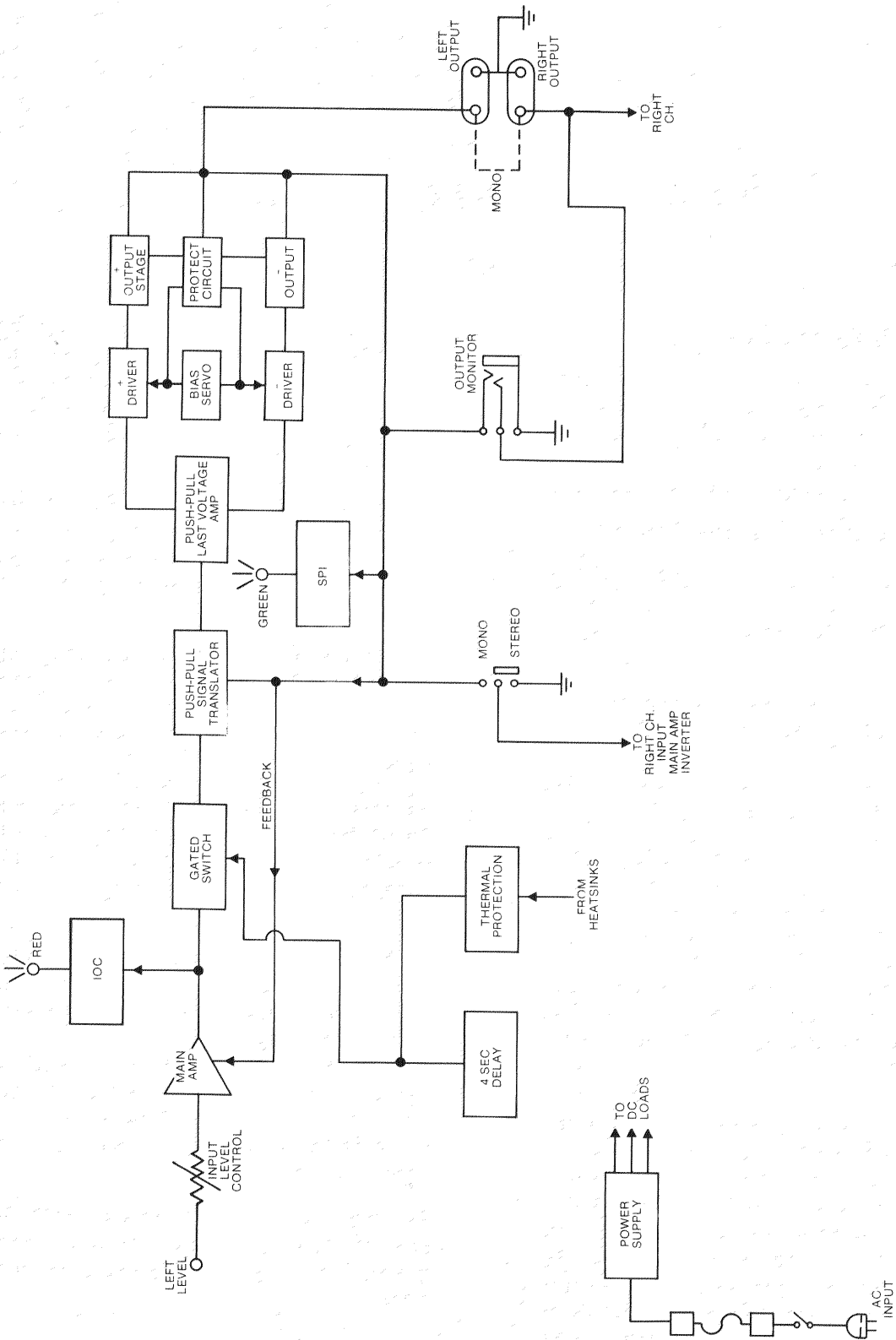
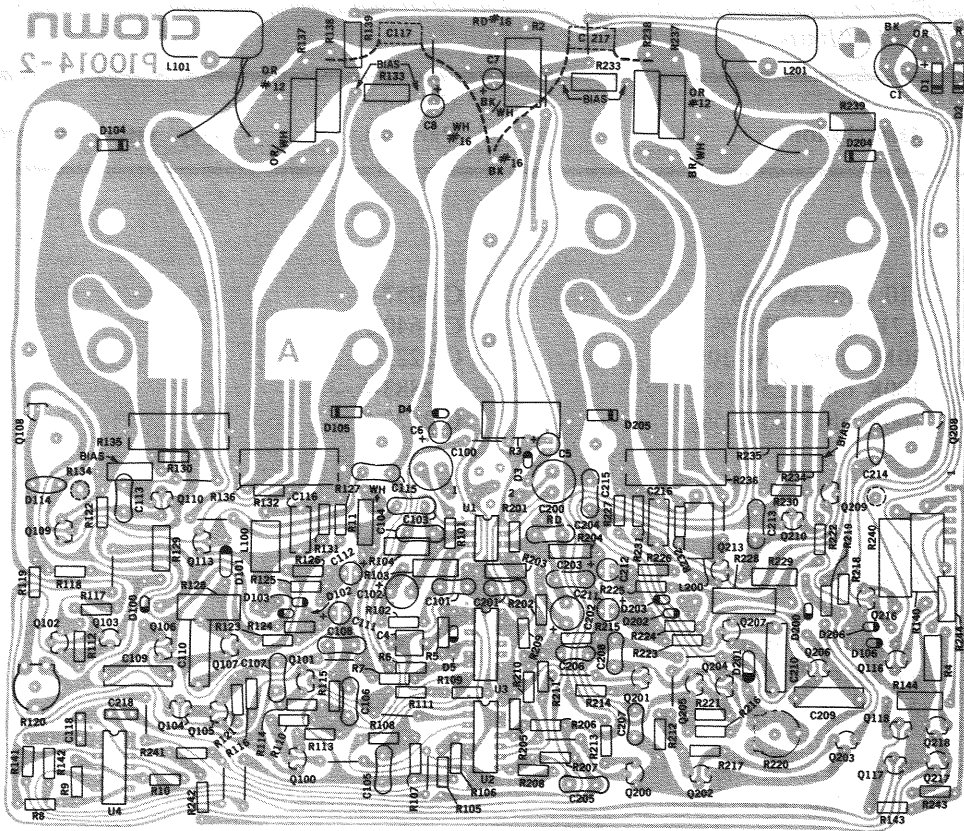
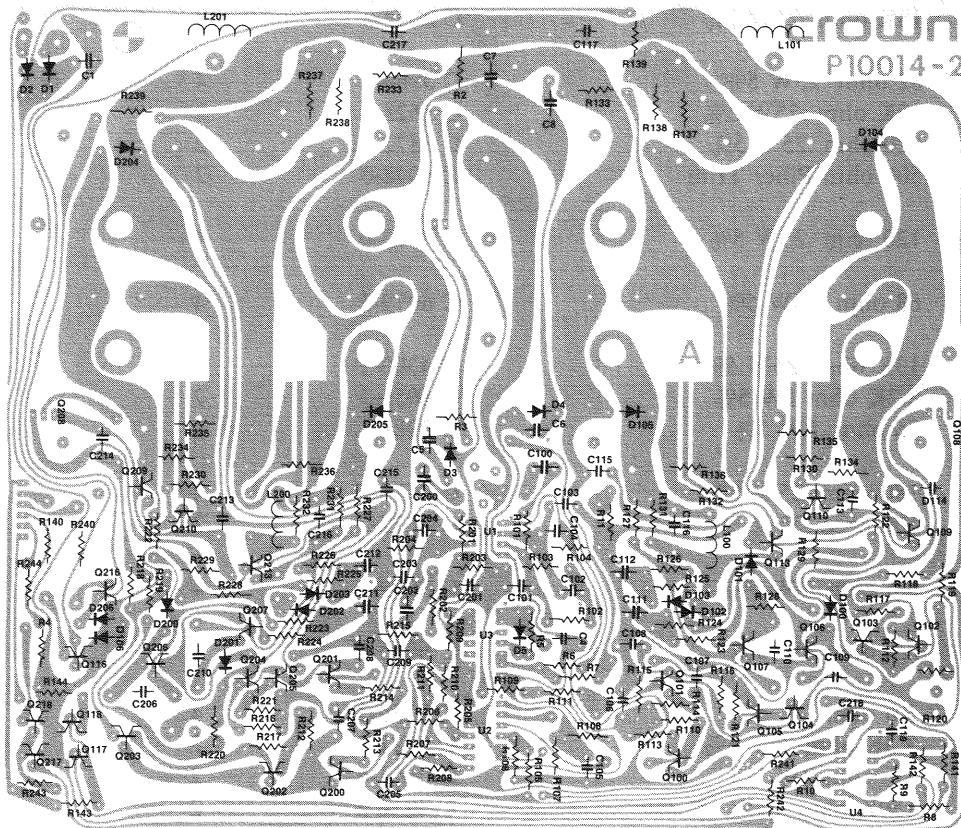

Fig. 4.1 Power Line Two Block Diagram





*Main Component Board Layout; P10014-2*



*Main Foil Board Layout; P10014-2*

Schematic Designation	Description	Crown Part No.	Qty.	Other Information
<b>Resistors</b>				
R2, R3	910 ohm 2W 5%	C 6057-1	2	
R4	4.7K ohm .5W 5%	C 1640-9	1	
R5	10M ohm .25W 10%	C 3221-6	1	
R6	100K ohm .25W 5%	C 2883-4	1	
R7	200K ohm .25W 5%	C 3622-5	1	
R8, R10, R102, R202, R105, R205, R108, R208	10K ohm .25W 5%	C 2631-7	8	
R9	68K ohm .25W 5%	C 3620-9	1	
R11, R104, R204	10K ohm .5W 1%	C 2343-9	3	
R101, R201	1K ohm .25W 5%	C 2627-5	2	
R103, R203	511 ohm .5W 1%	C 3304-0	2	
R106, R206, R107, R207	2K ohm .25W 5%	C 3804-9	4	
R109, R209	1.8K ohm .25W 5%	C 3807-2	2	
R110, R210, R111, R211	20K ohm .25W 5%	C 5046-5	4	
R112, R222, R116, R216	820 ohm .25W 5%	C 3301-6	4	
R113, R213, R114, R214	750 ohm .25W 5%	C 3803-1	4	
R115, R215	18K ohm .25W 5%	C 2633-3	2	
R117, R217, R121, R221	82 ohm .25W 5%	C 3960-9	4	
R118, R218	10K ohm .25W 5%	C 2628-3	2	
R119, R219	620 ohm .25W 5%	C 3872-6	2	
R120, R220	500 ohm Piher Trim	C 6048-0	2	
R122, R222, R127, R227	120 ohm .25W 5%	C 4723-0	4	
R123, R223, R126, R226	68 ohm .25W 5%	C 6079-5	4	
R124, R224, R125, R225	13K ohm .25W 5%	C 4300-7	4	
R128, R228	2.2K ohm 1W 5%	C 6056-3	2	
R129, R229	36 ohm .5W 5%	C 2988-1	2	
R130, R230, R132, R232	180 ohm .25W 5%	C 2873-5	4	
R131, R231	100 ohm .25W 5%	C 2872-7	2	
R133, R233, R134, R234	5.6 ohm .5W 5%	C 3299-2	4	
R135, R235, R136, R236	.25 ohm 5W 5%	C 6055-5	4	
R137, R237, R138, R238	5.6 ohm 1W 5%	C 2355-3	4	
R139, R239	3.3K ohm .5W 5%	C 1051-9	2	
R140, R240	2K ohm 2W 5%	C 3651-4	2	
R141, R241	150K ohm .25W 5%	C 4216-5	2	

Schematic Designation	Description	Crown Part No.	Qty.	Other Information
R142, R242	4.7K ohm .25W 5%	C 3939-3	2	
R143, R243	56K ohm .25W 5%	C 2882-6	2	
R144, R244	3.9K ohm .5W 5%	C 1059-2	2	
<b>Capacitors</b>				
C1	33mF 50V	C 3679-5	1	
C4	.47mF 100V 10% Poly	C 4119-1	1	
C5, C6, C7, C8	4.7mF 63V	C 4253-8	4	
C100, C200	22mF 50V NP 10%	C 5311-3	2	
C101, C201, C105, C205, C113, C213, C115, C215	200pF	C 3411-3	8	
C102, C202	100mF 16V	C 3729-8	2	
C103, C203	120pF Mica	C 3290-1	2	
C104, C204, C107, C207, C108, C208	27pF Mica	C 2342-1	6	
C106, C206	47pF Mica	C 3409-7	2	
C109, C209, C110, C210, C117, C217	.1mF 200V 10% Film	C 2938-6	6	
C111, C211, C112, C212	10mF 50V	C 3728-0	4	
C114, C214	.001mF	C 2288-6	2	
C116, C216	.0082mF 200V 10%	C 3063-2	2	
C118, C218	.1mF	C 5639-7	2	
<b>Diodes</b>				
D1, D2, D104, D204, D105, D205	1N4004	C 2851-1	6	
D3, D4	1N960B 9.1V Zener	C 5900-3	2	
D5, D100, D200, D102, D202, D103, D203, D106, D206	1N4148	C 3181-2	9	
D101, D201	1N270	C 3447-7	2	
<b>Transistors</b>				
Q100, Q200, Q105, Q205, Q106, Q206, Q108, Q208, Q116, Q216, Q117, Q217,				
Q118, Q218	SEL 2N3859A	D 2961-7	14	
Q101, Q201	PN4250A	C 3786-8	2	

Parts List: PL-2 Main Board #P10014-2 cont.

Schematic Designation	Description	Crown Part No.	Qty.	Other Information
Q102, Q202, Q107, Q207, Q109, Q209	2N4125	C 3625-8	6	
Q103, Q203, Q113, Q213	MPSA93	C 3578-9	4	
Q104, Q204, Q110, Q210	MPSA43	C 3810-6	4	
<b>Intergrated Circuits</b>				
U1	NE5532AP Dual Op-Amp	C 5881-5	1	
U2	MC14016 Quad Switch	C 4834-5	1	
U3	4081 Quad 2INP AND	C 4532-5	1	
U4	LM339N Volt Comparator	C 4345-2	1	
<b>Miscellaneous</b>				
Q111, Q211	MJE15030	C 5890-6	2	Added to module during factory assembly
Q112, Q212, Q115, Q215	MJ15015	C 4751-1	4	Added to module during factory assembly
Q114, Q214	TIP 47	C 4647-1	2	Added to module during factory assembly
R100, R200	25K ohm 31 pos. LVL CTL SPSTNC 160F Thermal Switch	D 5747-7 C 2799-2	2 1	
L100, L200	6 Pin SIP Socket	C 6013-4	1	
L101, L201	.5mH Axial Green 3mH Output Coil	C 3510-2 M42018-8	2 2	
	8 Pin DIL IC Socket	C 3451-9	1	Socket for U1
	14 Pin DIL IC Socket	C 3450-1	3	Socket for U2, U3, U4, U5
	Board, Main	P10014-2	1	
<b>Parts List: PL-2 LED Board #P10015-9</b>				
<b>Diodes</b>				
LED1	MV5153 Amber LED	C 4342-9	1	
LED 100, LED 200	T1 Red LED	C 5905-2	2	
LED 101, LED 201	TIL232-2 Green Mini LED	C 5098-6	2	
<b>Miscellaneous</b>				
	625X375X015 Fiber Washer	C 1646-6	4	
	6 Cond. 4 IN Flex Jumper	C 5857-5	1	
	L112B 3 Cond. Hi-D JAX	C 5892-2	1	
	Board, LED	P10015-9	1	

Parts List: PL-2 Chassis Mounted Parts

Schematic Designation	Description	Crown Part No.	Qty.	Other Information
R1	2.7 ohm 2W 10%	C 6046-4	1	
C2, C3	10,000mF 50V	C 4960-8	2	
C9	.1mF 200V 10% Film	C 2938-6	1	
SW1	Switch, Lever 25A SPST NO	D 5699-0	1	
SW2	DPDT Flush Bat	C 4992-1	1	
J1	L112B 3 Cond. Hi-D Jax	C 5892-2	1	
J100, J200	2 Way Phon JK RT Angle	C 4933-5	1	
J101, J201	Dual Binding Post	C 2823-0	2	
F1	MDA 3 Amp Fuse 1.25	C 4384-1	1	
T1	Transformer, 49-P-19A	D 5719A4	1	
DM1	VH148 6A Bridge	C 3062-4	1	

Schematic Designation	Description	Crown Part No.	Qty. Other Information
<b>Resistors</b>			
R132, R232	2.7 ohm 1W 10%	C 1001-4	2
R3, R4	1.5K ohm 1W 5%	C 3497-2	2
R5,			
R109, R209	10K ohm .5W 1%	C 2343-9	3
R134, R234	2K ohm 2W 5%	C 3651-4	2
R102, R202,			
R108, R208	1K ohm .25W 5%	C 2627-5	4
R103, R203	511 ohm .5W 1%	C 3304-0	2
R104, R204,			
R118, R218,			
R125, R225,			
R137, R237,			
R141, R241	10K ohm .25W 5%	C 2631-7	10
R105, R205	10K ohm .5W 5%	C 1035-2	2
R106, R206	18K ohm .25W 5%	C 2633-3	2
R107, R207	3K ohm .25W 5%	C 3805-6	2
R110, R210	820 ohm .25W 5%	C 3301-6	2
R111, R211	75 ohm .25W 5%	C 3798-3	2
R112, R212	2.2K ohm .25W 5%	C 2628-3	2
R114, R214	750 ohm .25W 5%	C 3803-1	2
R115, R215	240 ohm .25W 5%	C 4513-5	2
R116, R216,			
R126, R226	22K ohm .5W 5%	C 2082-3	4
R117, R217,			
R127, R227	120 ohm .5W 5%	C 3837-9	4
R119, R219	100 ohm .25W 5%	C 2872-7	2
R120, R220,			
R128, R228	180 ohm .25W 5%	C 2873-5	4
R121, R221,			
R129, R229	5.6 ohm .5W 5%	C 3299-2	4
R122, R222,			
R123, R223	4.7K ohm .5W 5%	C 1640-9	4
R124, R224	470 ohm .25W 5%	C 2626-7	2
R130, R230,			
R131, R231	.1 ohm 5W 10%	C 3291-9	4
R133, R233	3.3K ohm .25W 5%	C 2629-1	2
R135, R235	5.6K ohm .25W 5%	C 3220-8	2
R136, R236	100K ohm .25W 5%	C 2883-4	2
R138, R238	1M ohm .25W 5%	C 3198-6	2
R139, R239	15K ohm .25W 5%	C 2632-5	2
R140, R240	33K ohm .25W 5%	C 4346-0	2
R142, R242	1.5K ohm .5W 5%	C 1076-6	2
<b>Capacitors</b>			
C3, C4	220mF 16V	C 3796-7	2
C5, C7	4.7mF 63V	C 4253-8	2
C6	.02mF 50V	C 5230-5	1
C8,			
C116, C216	.1mF 200V 10% Film	C 2938-6	3
C101, C201	22mF 50V NP 10%	C 5311-3	2

Schematic Designation	Description	Crown Part No.	Qty.	Other Information
C102, C202, C108, C208, C113, C213	200pF	C 3411-3	6	
C103, C203	100mF 16V	C 3729-8	2	
C104, C204	27pF	C 2342-1	2	
C105, C205	120pF	C 3290-1	2	
C106, C206	82pF	C 3627-4	2	
C107, C207	47pF	C 3409-7	2	
C109, C209, C115, C215	.01mF 500V Disc	C 1751-4	4	
C110, C210, C114, C214	.1mF Mono	C 5639-7	4	
C111, C211	.0082mF 200V 10% Film	C 3063-2	2	
C112, C212	470mF 35V	C 4477-3	2	
C117, C217	.22mF 100V 10% Film	C 3218-2	2	
<b>Diodes</b>				
D1, D2 D3, D101, D201, D103, D203, D104, D204, D105, D205, D106, D206, D109, D209	1N4148	C 3181-2	13	
D102, D202	1N270	C 3447-7	2	
D107, D207, D108, D208	1N4004	C 2851-1	4	
<b>Transistors</b>				
Q101, Q201	PN4250A	C 3786-8	2	
Q102, Q202, Q104, Q204, Q109, Q209, Q114, Q214, Q115, Q215, Q116, Q216	SEL 2N3859A	D 2961-7	12	
Q103, Q203	MPSL01	C 3232-3	2	
Q105, Q205, Q110, Q210	2N4125	C 3625-8	4	
Q106, Q206	MPSA93	C 3578-9	2	
Q111, Q211	MPSA43	C 3810-6	2	
<b>Integrated Circuits</b>				
U1	NE532AP Dual Op-Amp	C 5881-5	1	
U2	LM339N Volt Comparator	C 4345-2	1	
<b>Miscellaneous</b>				
R1	1.2K 2W 10%	C 3649-8	1	
R101, R201	25K ohm 31 Pos. LVL Control	D 5747-7	2	

Parts List: PL-2 Main Board #P 9991A2 cont.

Schematic Designation	Description	Crown Part No.	Qty.	Other Information
	8 pin DIL IC Socket	C 3451-9	1	Socket for U1
	14 Pin DIL IC Socket	C 3450-1	1	Socket for U2
	6 Pin Sip Socket	C 6013-4	1	
L101, L102	.5mH Axial Green	C 3510-2	2	
L102, L202	Output Coil	M42018-8	2	
Q107, Q207	Tip 47 Power NPN	C 4647-1	2	Added to module during factory assembly
Q108, Q208, Q113, Q213	MJ15015 Power NPN	C 4751-1	4	Added to module during factory assembly
Q112, Q212	MJE15030 Power NPN	C 5890-6	2	Added to module during factory assembly
	Board, Main	P 9991A2	1	

Parts List: PL-2 LED Board #P 9995-5

**Diodes**

LED1	MV5153 Amber LED	C 4342-9	1	
LED 101, LED 201	T1 Red LED	C 5905-2	2	
LED 102, LED 202	TIL232-2 Green Mini LED	C 5098-6	2	

**Miscellaneous**

	625X375X015 Fiber Washer	C 1646-6	4	
	6 Cond. 4 IN Flex Jumper	C 5857-5	1	
	L112B 3 Cond. Hi-D JAX	C 5892-2	1	
	Board, LED	P 9995-5	1	

Parts List: PL-2 Chassis Mounted Parts

R2	2.7 ohm 2W 10%	C 6046-4	1	
R6	2K ohm 2W 5%	C 3651-4	2	
C1, C2	10,000mF 50V	C 4960-8	2	
C9	.1mF 12V Disc	C 2600-2	1	
DM-1	VH148 6A Bridge	C 3062-4	1	
SW1	Switch, Lever 25A SPST NO	D 5699-0	1	
SW2	SPSTNC 160f Therm Switch	C 2799-2	1	
SW3	DPDT Flush Bat	C 4992-1	1	
J101, J201	2 way Phone Jack RT Angle	C 4933-5	1	
J102, J202	Dual Binding Post	C 2823-0	2	
F1	MDA 3 Amp Fuse 1.25	C 4384-1	1	
	Transformer; 49-P-19A	D 5719A4	1	
	Output Monitor Jack; L112B 3 Cond. HI-D Jax	C 5892-2	1	